

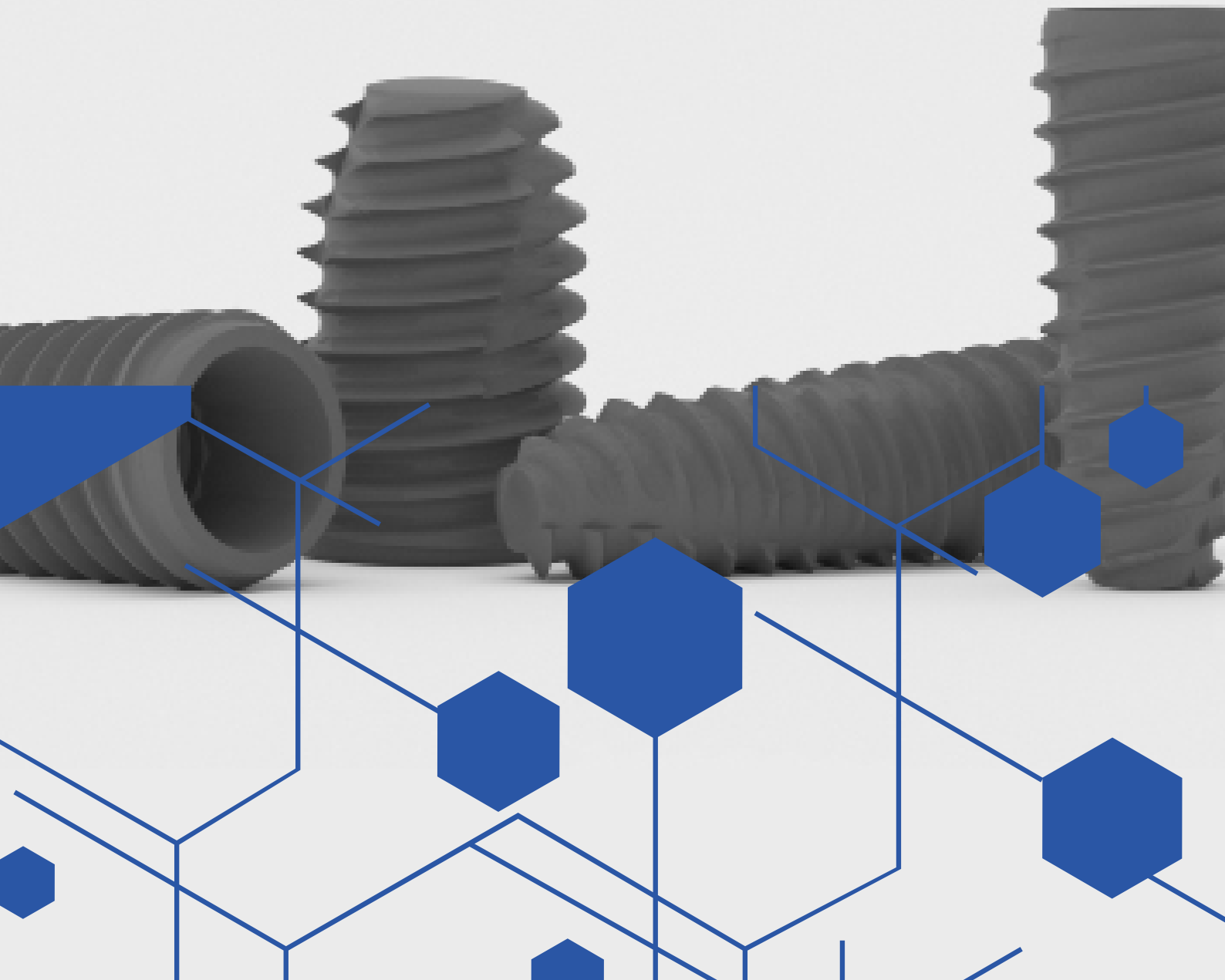

# Implant System

## Product Catalog



# About Nexplant

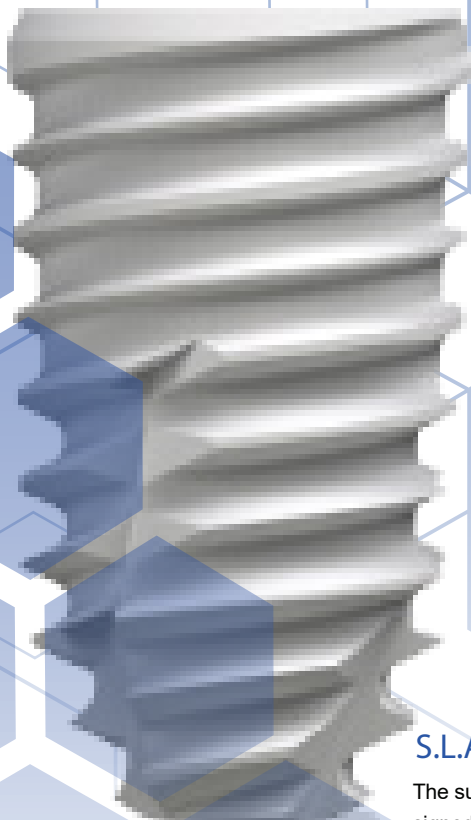

## Fixture Design

The Nexplant Implant System is designed to handle a range of treatment options from a single tooth replacement to a full mouth case. The advanced engineering of a tapered body combined with the specialized thread design gives the doctors the comfort and confidence to perform the procedure effectively with immediate and early loading. The Nexplant Implant System has a unique design, making it easy and safe to place without the risk of damage from highly complex and limited anatomical conditions (i.e. maxillary sinus and inferior alveolar nerve).

## Fixture Types

Nexplant offers a wide variety of implant fixtures. Ranging from your Mini Implant Series to your Standard Size Fixture as well as a Wide Series Fixture. Nexplant provides a clear organized color distinction between implant types and sizes. Allowing the procedure to seamlessly move forward with ease of use and limitation in error. The Mini Series is ideal for narrow spaces, such as the maxillary or mandibular anterior. The Nexplant Implant system has provided doctors a wide selection of Ball Implants, One-piece Implants and various other components to help guide and ease the procedure of all implant cases.

## S.L.A Surface.

The surface of the Nexplant fixture has been designed with the most efficient and reliable surface material. Its excellent morphology and roughness provides an increased surface area to RBM Ratio of about 50%. The surface treatment combined with the tapered shape of the fixture provides a stable and adequate solution for all implant procedures.

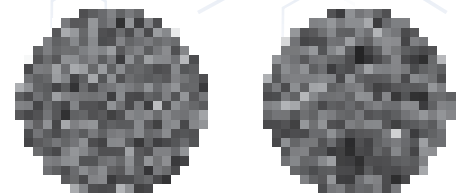

## Convenient Surgery

Nexplant has a unique design which makes easy and safe installation without any damage in the case of limited anatomical conditions, i.e. maxillary sinus inferior alveolar nerve.

## Stable Connection

Two types of connection are applied to Nexplant for clear distinction. You can easily tell one from the other with its definite color difference.

## Cutting Edge Design

The cutting edge thread, applied to the surface of the fixture is designed for convenient path modification as well as tapping ability at any bone conditions.

## Double Thread Hybrid Technology

Modern cutting edge technology allows Nexplant<sup>TM</sup> to provide an implant with a specialized double thread surface giving it a convenient path modification, as well as tapping ability for any bone condition/type. The width and height of each thread is designed differently from one another to give an advantage in various bone types while minimizing the loss of unnecessary bone, including D1 and D2 bone.

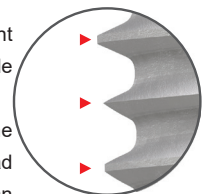

# Prosthetics Flow Diagram for Nexplant System

Screw & Cement Retained Restoration

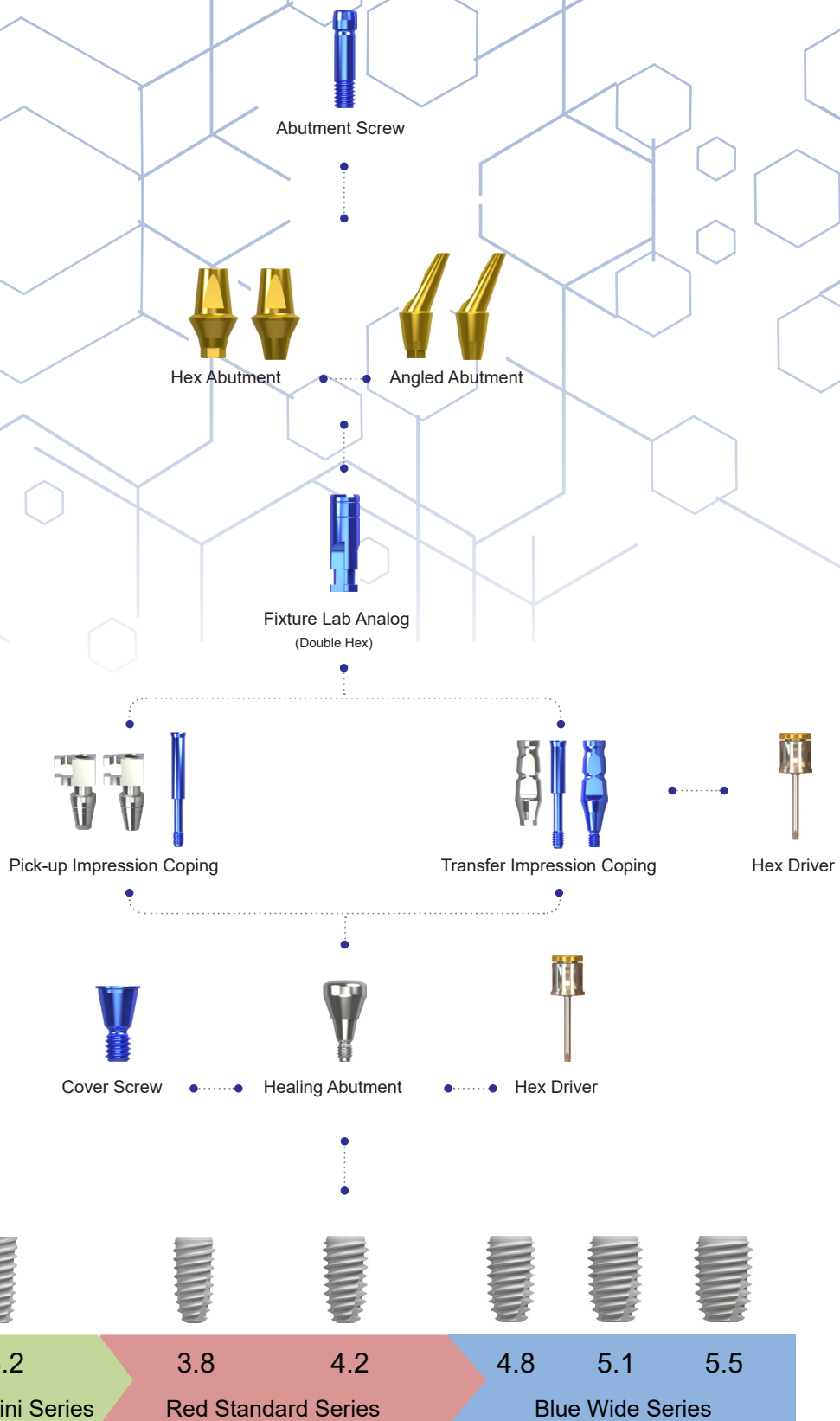

# Implant Fixture

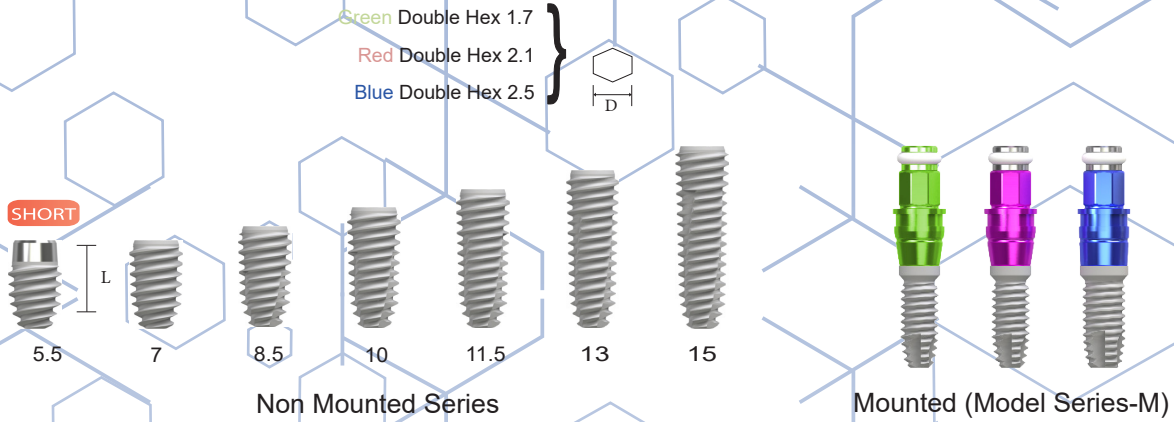

Mini Implant (Green)		
Connection		
L \ D		ø3.2
	8.5	I3285
	10	I3210
	11.5	I3211
	13	I3213
	15	I3215

Standard Implant (Red)				
Connection <sub>p</sub>	Non-Mounted	Mounted	Non-Mounted	Mounted
L \ D	ø3.8		ø4.2	
7	I3807	I3807M	I4207	I4207M
8.5	I3885	I3885M	I4285	I4285M
10	I3810	I3810M	I4210	I4210M
11.5	I3811	I3811M	I4211	I4211M
13	I3813	I3813M	I4213	I4213M
15	I3815	I3815M	I4215	I4215M

Wide Implant (Blue)						
Connection	Non-Mounted	Mounted	Non-Mounted	Mounted	Non-Mounted	Mounted
Connection	ø4.8		ø5.1		ø5.5	
7	I4607	I4607M	I5107	I5107M	I5507	I5507M
8.5	I4685	I4685M	I5185	I5185M	I5585	I5585M
10	I4610	I4610M	I5110	I5110M	I5510	I5510M
11.5	I4611	I4611M	I5111	I5111M	I5511	I5511M
13	I4613	I4613M	I5113	I5113M	I5513	I5513M
15	I4615	I4615M	I5115	I5115M	I5515	I5515M

# Healing Abutment

## Mini Healing Abutment (Green)

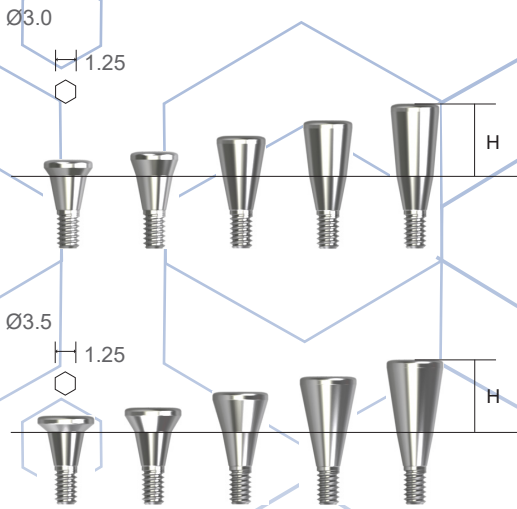

Connection		
L \ D	Ø3.0	Ø3.5
1	MHA3010	MHA3510
1.5	MHA3015	MHA3515
2.5	MHA3025	MHA3525
3.5	MHA3035	MHA3535
4.5	MHA3045	MHA3545

- Use 1.25 Hex Driver
- Optimum torque : 5-8Ncm
- Mini Screw (Green) : M1.4

## Standard Healing Abutment (Red)

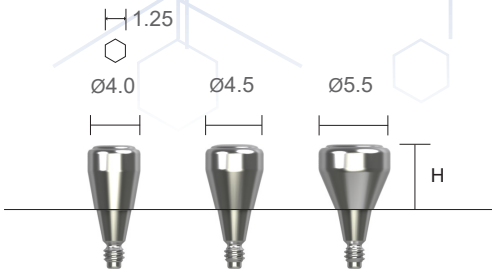

Connection			
H \ D	Ø4.0	Ø4.5	Ø5.5
3.5	S-HA4035	S-HA4535	S-HA5535
5	S-HA4050	S-HA4550	S-HA5550
7	S-HA4070	S-HA4570	S-HA5570

- Use 1.25 Hex Driver
- Optimum torque : 5-8Ncm
- Standard Screw (Red) : M1.6

## Wide Healing Abutment (Blue)

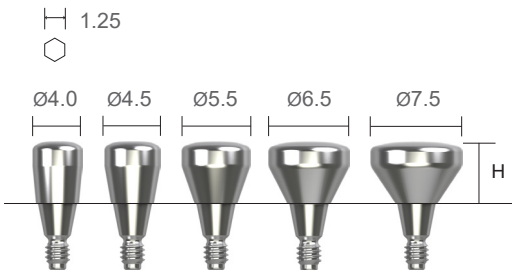

Connection					
H \ D	Ø4.0	Ø4.5	Ø5.5	Ø6.5	Ø7.5
3.5	W-HA4035	W-HA4535	W-HA5535	W-HA6535	W-HA7535
5	W-HA4050	W-HA4550	W-HA5550	W-HA6550	W-HA7550
7	W-HA4070	W-HA4570	W-HA5570	W-HA6570	W-HA7570

- Use 1.25 Hex Driver
- Optimum torque : 5-8Ncm
- Wide Screw (Blue) : M2.0t

# Mini Abutment (Green)

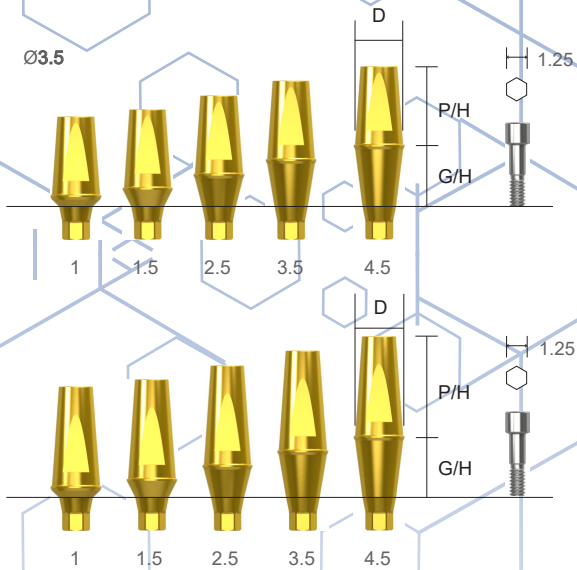

D		Hex	
P/H	G/H	Type	
5.5		ø3.5	
		1	M-AB351055
		1.5	M-AB351555
		2.5	M-AB352555
		3.5	M-AB353555
7		4.5	M-AB354555
		1	M-AB351070
		1.5	M-AB351570
		2.5	M-AB352570
		3.5	M-AB353570
	4.5	M-AB354570	

- Designed for general cement type prosthesis
- One body structure (abutment with screw)
- 22° taper structure for stable connection
- Colored in gold for esthetic satisfaction
- Profile for anti-rotation of prosthesis
- Use 1.25 Hex driver
- Optimum torque : 20Ncm
- Mini Screw (Green) : M1.4

# Standard Abutment (Red)

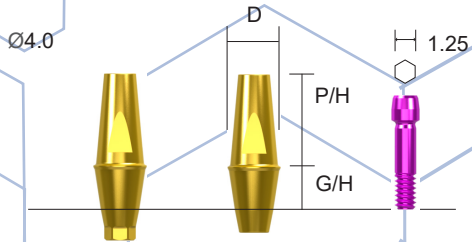

Hex Non-Hex

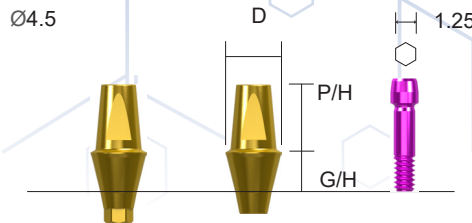

Hex Non-Hex

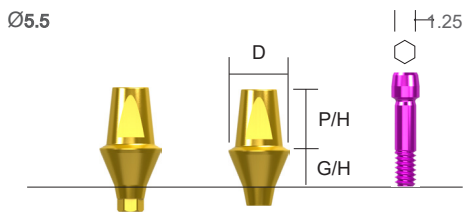

Hex Non-Hex

- Designed for general cement type prosthesis
- One body structure (abutment with screw)
- 11° taper structure for stable connection
- Colored in gold for esthetic satisfaction
- Profile for anti-rotation of prosthesis
- Use 1.25 Hex driver
- Optimum torque : 20Ncm (Red)
- Red : Hex 2.1
- Standard Screw (Red) : M1.6

D		Ø4.0		
P/H	G/H	Type	Hex	Non-Hex
7	1		S-AB401070H	S-AB401070N
	1.5		S-AB401570H	S-AB401570N
	2.5		S-AB402570H	S-AB402570N
	3.5		S-AB403570H	S-AB403570N
	4.5		S-AB404570H	S-AB404570N
	5.5		S-AB405570H	S-AB405570N

D		Ø4.5		
P/H	G/H	Type	Hex	Non-Hex
4	1		S-AB451040H	S-AB451040N
	1.5		S-AB451540H	S-AB451540N
	2.5		S-AB452540H	S-AB452540N
	3.5		S-AB453540H	S-AB453540N
	4.5		S-AB454540H	S-AB454540N
	5.5		S-AB455540H	S-AB455540N
5.5	1		S-AB451055H	S-AB451055N
	1.5		S-AB451555H	S-AB451555N
	2.5		S-AB452555H	S-AB452555N
	3.5		S-AB453555H	S-AB453570N
	4.5		S-AB454555H	S-AB454555N
	5.5		S-AB455555H	S-AB455555N
7	1		S-AB451070H	S-AB451070N
	1.5		S-AB451570H	S-AB451570N
	2.5		S-AB452570H	S-AB452570N
	3.5		S-AB453570H	S-AB453570N
	4.5		S-AB454570H	S-AB454570N
	5.5		S-AB455570H	S-AB455570N

D		ø5.5		
P/H	G/H	Type	Hex	Non-Hex
4	1.5		S-AB551540H	S-AB551540N
	2.5		S-AB552540H	S-AB552540N
	3.5		S-AB553540H	S-AB553540N
	4.5		S-AB554540H	S-AB554540N
	5.5		S-AB555540H	S-AB555540N
5.5	1.5		S-AB551555H	S-AB551555N
	2.5		S-AB552555H	S-AB552555N
	3.5		S-AB553555H	S-AB553555N
	4.5		S-AB554555H	S-AB554555N
	5.5		S-AB555555H	S-AB555555N
7	1.5		S-AB551570H	S-AB551570N
	2.5		S-AB552570H	S-AB552570N
	3.5		S-AB553570H	S-AB553570N
	4.5		S-AB554570H	S-AB554570N
	5.5		S-AB555570H	S-AB555570N

# Wide Abutment (Blue)

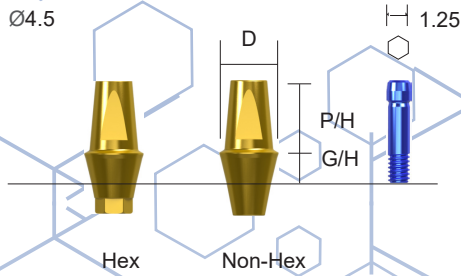

- Designed for general cement type prosthesis
- One body structure (abutment with screw)
- 11°taper structure for stable connection
- Colored in gold for esthetic satisfaction
- Profile for anti-rotation of prosthesis
- Use 1.25 Hex driver
- Optimum torque : 30Ncm (Blue)
- Blue : Hex 2.5
- Wide Screw (Blue) : M2.0

D		Ø4.5	
P/H	G/H	Type	
		Hex	Non-Hex
4	1	W-AB451040H	W-AB451040N
	1.5	W-AB451540H	W-AB451540N
	2.5	W-AB452540H	W-AB452540N
	3.5	W-AB453540H	W-AB453540N
	4.5	W-AB454540H	W-AB454540N
5.5	5.5	W-AB455540H	W-AB455540N
	1	W-AB451055H	W-AB451055N
	1.5	W-AB451555H	W-AB451555N
	2.5	W-AB452555H	W-AB452555N
	3.5	W-AB453555H	W-AB453555N
7	4.5	W-AB454555H	W-AB454555N
	5.5	W-AB455555H	W-AB455555N
	1	W-AB451070H	W-AB451070N
	1.5	W-AB4515 70H	W-AB4515 70N
	2.5	W-AB4525 70H	W-AB4525 70N
	3.5	W-AB4535 70H	W-AB4535 70N
	4.5	W-AB4545 70H	W-AB4545 70N
	5.5	W-AB4555 70H	W-AB4555 70N

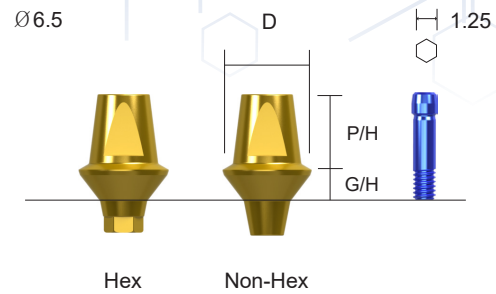
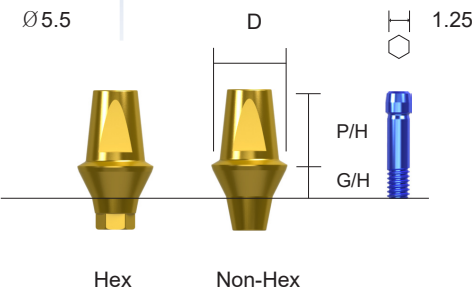

D		Ø5.5	
P/H	G/H	Type	
		Hex	Non-Hex
4	1.5	W-AB551540H	W-AB5515 40N
	2.5	W-AB552540H	W-AB 552540N
	3.5	W-AB553540H	W-AB5535 40N
	4.5	W-AB554540H	W-AB5545 40N
	5.5	W-AB555540H	W-AB5555 40N
5.5	1.5	W-AB551555H	W-AB551555N
	2.5	W-AB552555H	W-AB552555N
	3.5	W-AB553555H	W-AB553555N
	4.5	W-AB554555H	W-AB554555N
	5.5	W-AB555555H	W-AB555555N
7	1.5	W-AB5515 70H	W-AB5515 70N
	2.5	W-AB5525 70H	W-AB5525 70N
	3.5	W-AB5535 70H	W-AB5535 70N
	4.5	W-AB5545 70H	W-AB5545 70N
	5.5	W-AB5555 70H	W-AB5555 70N

D		Ø6.5	
P/H	G/H	Type	
		Hex	Non-Hex
4	1.5	W-AB6515 40H	W-AB6515 40N
	2.5	W-AB6525 40H	W-AB6525 40N
	3.5	W-AB6535 40H	W-AB6535 40N
	4.5	W-AB6545 40H	W-AB6545 40N
	5.5	W-AB6555 40H	W-AB6555 40N
5.5	1.5	W-AB6515 55H	W-AB6515 55N
	2.5	W-AB6525 55H	W-AB6525 55N
	3.5	W-AB6535 55H	W-AB6535 55N
	4.5	W-AB6545 55H	W-AB6545 55N
	5.5	W-AB6555 55H	W-AB6555 55N
7	1.5	W-AB6515 70H	W-AB6515 70N
	2.5	W-AB6525 70H	W-AB6525 70N
	3.5	W-AB6535 70H	W-AB6535 70N
	4.5	W-AB6545 70H	W-AB6545 70N
	5.5	W-AB6555 70H	W-AB6555 70N



# Angled Abutment

## Standard Angled Abutment (Red)

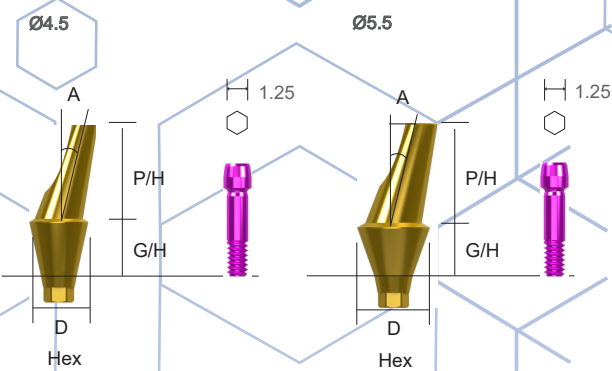

D			Ø4.5	Ø5.5
Angled	P/H	G/H	Type	Hex
15°	8	2	S-AAB45215H	S-AAB55215H
		4	S-AAB45415H	S-AAB55415H
		6	S-AAB45615H	S-AAB55615H
25°	8	2	S-AAB45225H	S-AAB55225H
		4	S-AAB45425H	S-AAB55425H
		6	S-AAB45625H	S-AAB55625H

- It is applied to adjust a path for prosthesis with its 15°, 30° axial angle
- 11° tapered structure for stable connection
- Colored in gold for esthetic satisfaction
- Use 1.25 Hex driver
- Optimum torque : 20Ncm (Red)
- Red : Hex 2.1
- Standard Screw (Red) : M1.6

## Wide Angled Abutment (Blue)

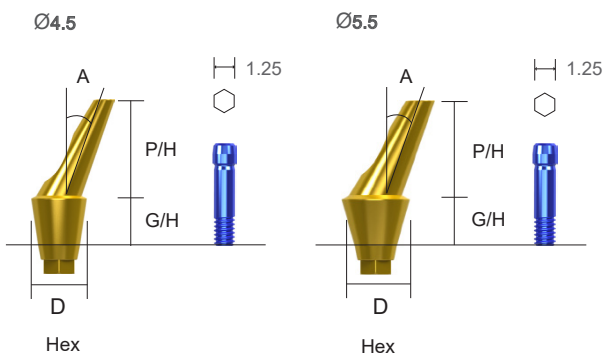

D			Ø4.5	Ø5.5
Angled	P/H	G/H	Type	Hex
15°	8	2	W-AAB45215H	W-AAB55215H
		4	W-AAB45415H	W-AAB55415H
		6	W-AAB45615H	W-AAB55615H
25°	8	2	W-AAB45225H	W-AAB55225H
		4	W-AAB45425H	W-AAB55425H
		6	W-AAB45625H	W-AAB55625H

- It is applied to adjust a path for prosthesis with its 15°, 30° axial angle
- 11° tapered structure for stable connection
- Colored in gold for esthetic satisfaction
- Use 1.25 Hex driver
- Optimum torque : 30Ncm (Blue)
- Blue : Hex 2.5
- Wide Screw (Blue) : M2.0

# Open Tray Impression Coping

## Open Tray Mini Impression Coping (Green)

L	G/H	Ø3.5
13.3		M-OTI35

- Pick-up type impression coping with the custom Tray
- The item is designed to minimize ill-fitting application in the impression material
- Asymmetric design is applied to minimize adjacent interference
- Green : Hex 1.7
- Mini Screw (Green) : M1.4

## Open Tray Standard Impression Coping (Red)

L	Type	D	Ø4.0	Ø4.5	Ø5.5
11	Hex		S-OTI40SH	S-OTI45SH	S-OTI55SH
15	Hex		S-OTI40LH	S-OTI45LH	S-OTI55LH

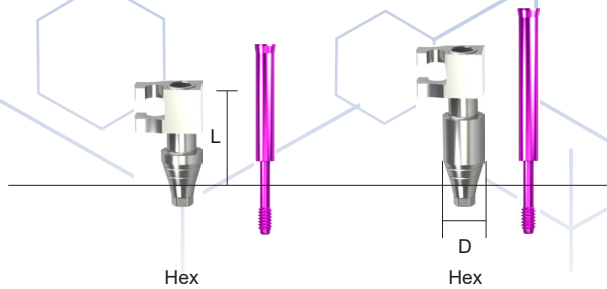

- Pick-up type impression coping with the custom Tray
- The item is designed to minimize ill-fitting application in the impression material
- Asymmetric design is applied to minimize adjacent interference
- Height variations(Long & Short) for convenience
- Red : Hex 2.1
- Standard Screw (Red) : M1.6

## Open Tray Wide Impression Coping (Blue)

L	Type	D	Ø4.0	Ø4.5	Ø5.5	Ø6.5
11	Hex		W-OTI40SH	W-OTI45SH	W-OTI55SH	W-OTI65SH
15	Hex		W-OIT40LH	W-OTI45LH	W-OTI55LH	W-OTI65LH

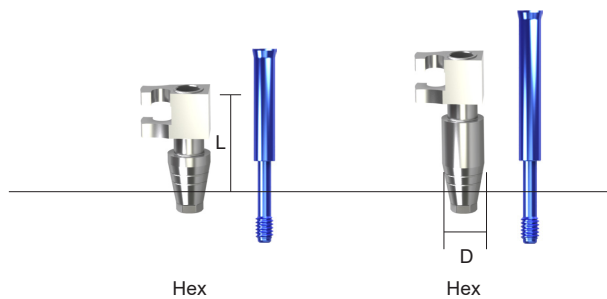

- Pick-up type impression coping with the custom Tray
- The item is designed to minimize ill-fitting application in the impression material
- Asymmetric design is applied to minimize adjacent interference
- Height variations(Long & Short) for convenience
- Blue : Hex 2.5
- Wide Screw (Blue) : M2.0

# Closed Tray Impression Coping

## Closed Tray Mini Impression Coping (Green)

L	G/H	Ø3.5
14.3		M-CTI35

- Transfer type impression coping with the custom tray
- Curved contour for increasing insertion ability
- Height variations (Long & Short) for convenience
- Green : Hex 1.7
- Mini Screw (Green) : M1.4

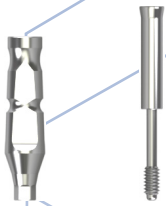

## Closed Tray Impression Coping (Red)

L	Type	D	Ø4.0	Ø4.5	Ø5.5
12	Hex		S-CTI40SH	S-CTI45SH	S-CTI55SH
16	Hex		S-CTI40LH	S-CTI45LH	S-CTI55LH

- Transfer type impression coping with the custom tray
- Curved contour for increasing insertion ability
- Height variations (Long & Short) for convenience
- Red : Hex 2.1
- Standard Screw (Red) : M1.6

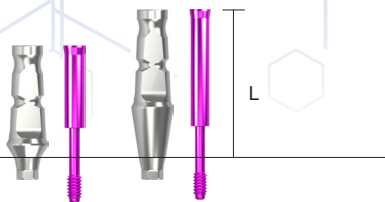

Hex

Hex

## Closed Tray Impression Coping (Blue)

L	Type	D	Ø4.0	Ø4.5	Ø5.5	Ø6.5
12	Hex		W-CTI40S	W-CTI45S	W-CTI55S	W-CTI65S
16	Hex		W-CTI40L	W-CTI45L	W-CTI55L	W-CTI65L

- Transfer type impression coping with the custom tray
- Curved contour for increasing insertion ability
- Height variations (Long & Short) for convenience
- Blue : Hex 2.5
- Wide Screw (Blue) : M2.0

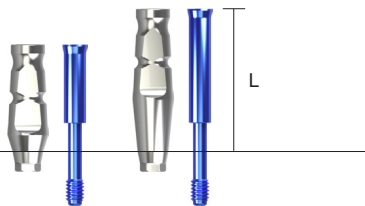

Hex

Hex

# Temporary Abutment & Fixture Lab Analog

## Temporary Abutment (Green)

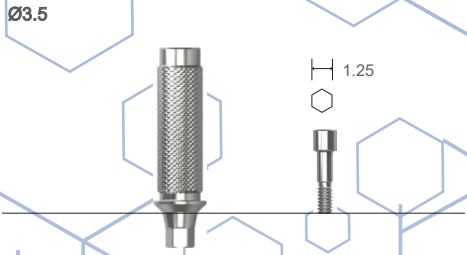

P/H	G/H	D	Ø3.5
1		10	M-TAB35

- Use to make the temporary prosthesis
- The structure is easy to customize
- Use 1.25 Hex Driver
- Optimum torque : 20Ncm
- Green : Hex 1.7
- Mini Screw (Green) : M1.4

## Temporary Abutment (Red)

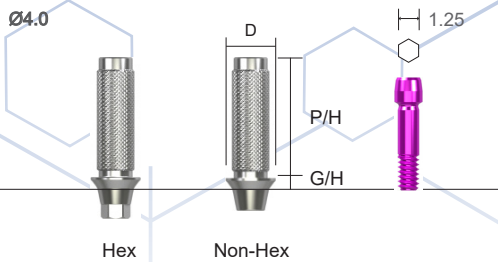

G/H	P/H	Type	D	Ø4.0
1	10	Hex		S-TAB40H
		Non-Hex		S-TAB40N

- Use to make the temporary prosthesis
- The structure is easy to customize
- Use 1.25 Hex Driver
- Optimum torque : 20Ncm
- Red : Hex 2.1
- Standard Screw (Red) : M1.6

## Temporary Abutment (Blue)

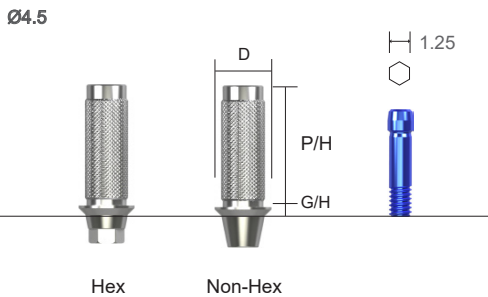

G/H	P/H	Type	D	Ø4.5
1	10	Hex		W-TAB45H
		Non-Hex		W-TAB45N

- Use to make the temporary prosthesis
- The structure is easy to customize
- Use 1.25 Hex Driver
- Optimum torque : 20Ncm
- Blue : Hex 2.5
- Wide Screw (Blue) : M2.0

## Fixture Lab Analog

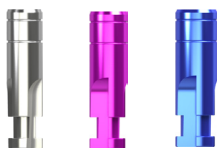

Green
M-ANAL
Red
S-ANAL
Blue
W-ANAL

# Prosthetics Flow Diagram for Nexplant Mini System

Cement Retained Restoration / Overdenture Retained Restoration [ Nexplant One Piece Fixture ]



Temporary Cap



Post Lab Analog



Mini Impression Coping



[Post Type]



MINI 2.8



MINI 3.2

# One Piece Implant

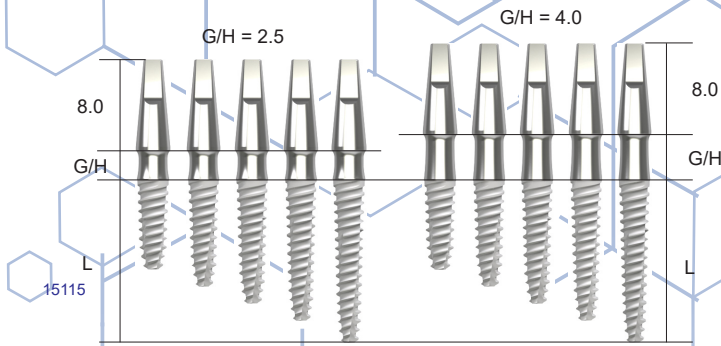

Mini One Piece Implant (Green)					
Connection		ø 2.8		ø 3.2	
L \ D	2.5	4.0	2.5	4.0	
8.5	IOP2885-25	IOP2885-40	IOP3285-25	IOP3285-40	
10	IOP2810-25	IOP2810-40	IOP3210-25	IOP3210-40	
11.5	IOP2811-25	IOP2811-40	IOP3211-25	IOP3211-40	
13	IOP2813-25	IOP2813-40	IOP3213-25	IOP3213-40	
15	IOP2815-25	IOP2815-40	IOP3215-25	IOP3215-40	

## Mini One Piece Impression Coping



- Used in taking impression of the simplex abutment.
- Hex 1.7 / Screw -M1.4

## Temporary One Piece Cap



- Use it to make the temporary prosthesis.

## Post Lab One Piece Analog



- The item is made on the model of the actual post type fixture abutment

# Prosthetics Flow Diagram for Nexplant Mini System

Cement Retained Restoration / Overdenture Retained Restoration [ Nexplant Ball Fixture ]



Ball Cap



Ball Lab Analog



[Ball Type]



Handpiece Connector  
(Ball)



MINI  
2.8



MINI  
3.2

# Ball Implant

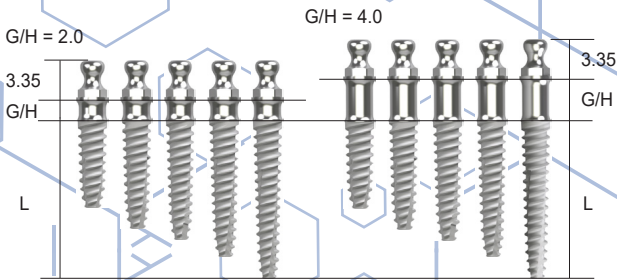

Mini Ball Implant (Green)					
Connection		ø 2.8		ø 3.2	
L	D	2.5	4.0	2.5	4.0
8.5		IOPB2885-20	IOPB2885-40	IOPB3285-20	IOPB3285-40
10		IOPB2810-20	IOPB2810-40	IOPB3210-20	IOPB3210-40
11.5		IOPB2811-20	IOPB2811-40	IOPB3211-20	IOPB3211-40
13		IOPB2813-20	IOPB2813-40	IOPB3213-20	IOPB3213-40
15		IOPB2815-20	IOPB2815-40	IOPB3215-20	IOPB3215-40

## Ball Analog



D	Ø4.0
-	B-ANAL

- The item is made on the model of the actual ball abutment.

## Ball Cap



D	Ø5.0
-	B-CAP

- Consists of O-Ring
- Allow maximum 20 degrees path
- Replace cycle : 6 months

## Ball Abutment

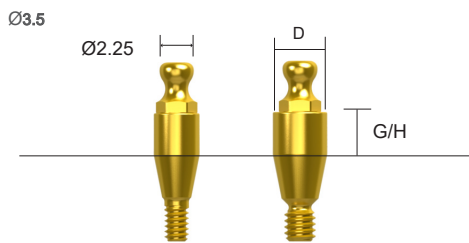

- Item for ball type over denture prosthesis
- Allow maximum 20 degrees path
- Use Ball driver
- Optimum torque : 30Ncm

Connection		Standard (Red)	Wide (Blue)
G/H	D	Ø3.5	Ø3.5
0.5		S-BAB00	W-BAB00
1		S-BAB01	W-BAB01
2		S-BAB02	W-BAB02
3		S-BAB03	W-BAB03
4		S-BAB04	W-BAB04
5		S-BAB05	W-BAB05
6		S-BAB06	W-BAB06
7		S-BAB07	W-BAB07

## Ball Lab Analog



D	Ø4.0
-	B-ANAL

- The item is made on the model of the actual ball abutment



# Nexplant Hybrid System

## Nexplant Screw Abutment (Red)

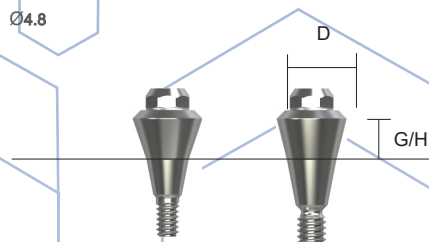

- Use it for the bridge case prosthesis which deviates from the normal path
- Apply the prosthesis with the plastic abutment after connection this item with the abutment in oral cavity
- Optimum torque : 30Ncm
- Red : Octa 3.0
- Standard Screw (Red) : M1.6

Connection		
G/H	D	Ø4.8
1		NB-A10S
2		NB-A20S
3		NB-A30S
4		NB-A40S
5		NB-A50S

## Nexplant Screw Abutment (Blue)

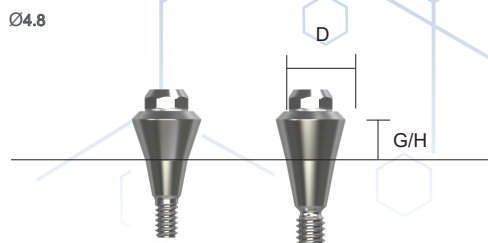

- Use it for the bridge case prosthesis which deviates from the normal path
- Apply the prosthesis with the plastic abutment after connection this item with the abutment in oral cavity
- Optimum torque : 30Ncm
- Blue : Octa 3.0
- Wide Screw (Blue) : M2.0

Connection		
G/H	D	Ø4.8
1		NB-A10W
2		NB-A20W
3		NB-A30W
4		NB-A40W
5		NB-A50W

## Nexplant Temporary Abutment

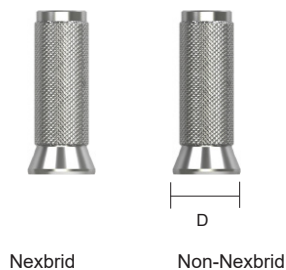

D	Ø5.0	
Type	Nexplant	Non-Nexplant
-	NB-TEMH	NB-TEMN

- Use it to make the temporary prosthesis
- The structure is easy to customize
- Use 1.2 Hex Driver
- Optimum torque : 20Ncm
- Octa 3.0 / Screw - M2.0

# Nexplant Hybrid System

## Nexplant Plastic Abutment

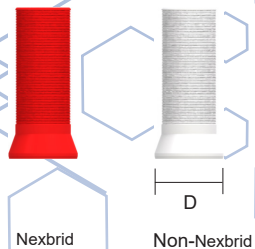

D	Ø5.0	
Type	Nexplant	Non-Nexplant
-	NB-ACH	NB-CAN

- Octa-screw abutment for screw retained prosthesis
- It is used for casting the dental alloy (Gold, non-precious metal) after customizing
- Use 1.2 Hex Driver
- Optimum torque : 20Ncm
- Octa 3.0

## Nexplant Impression Coping

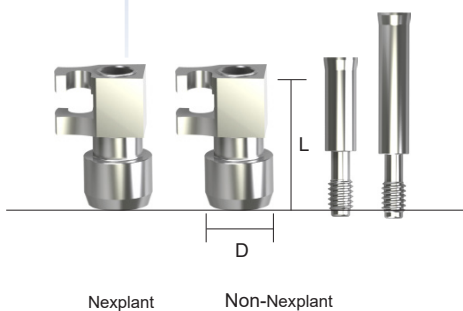

Type	L	D	Ø5.5
Nexplant	11		NB-IMPH-O
Non-Nexplant			NB-IMPH-N

- Pick-up type impression coping with the Custom tray
- The item is designed to minimize ill fitting application in the impression material
- Asymmetric design is applied to minimize adjacent interference
- Height variations (Long & Short) for convenience
- Octa 3.1 / Screw - M2.0

## Nexplant Lab Analog



NB-LABA
---------

- The item is made on the model of the actual octa-screw abutment
- Octa 3.0

# Nexplant Surgical Kit

## NK-SURG

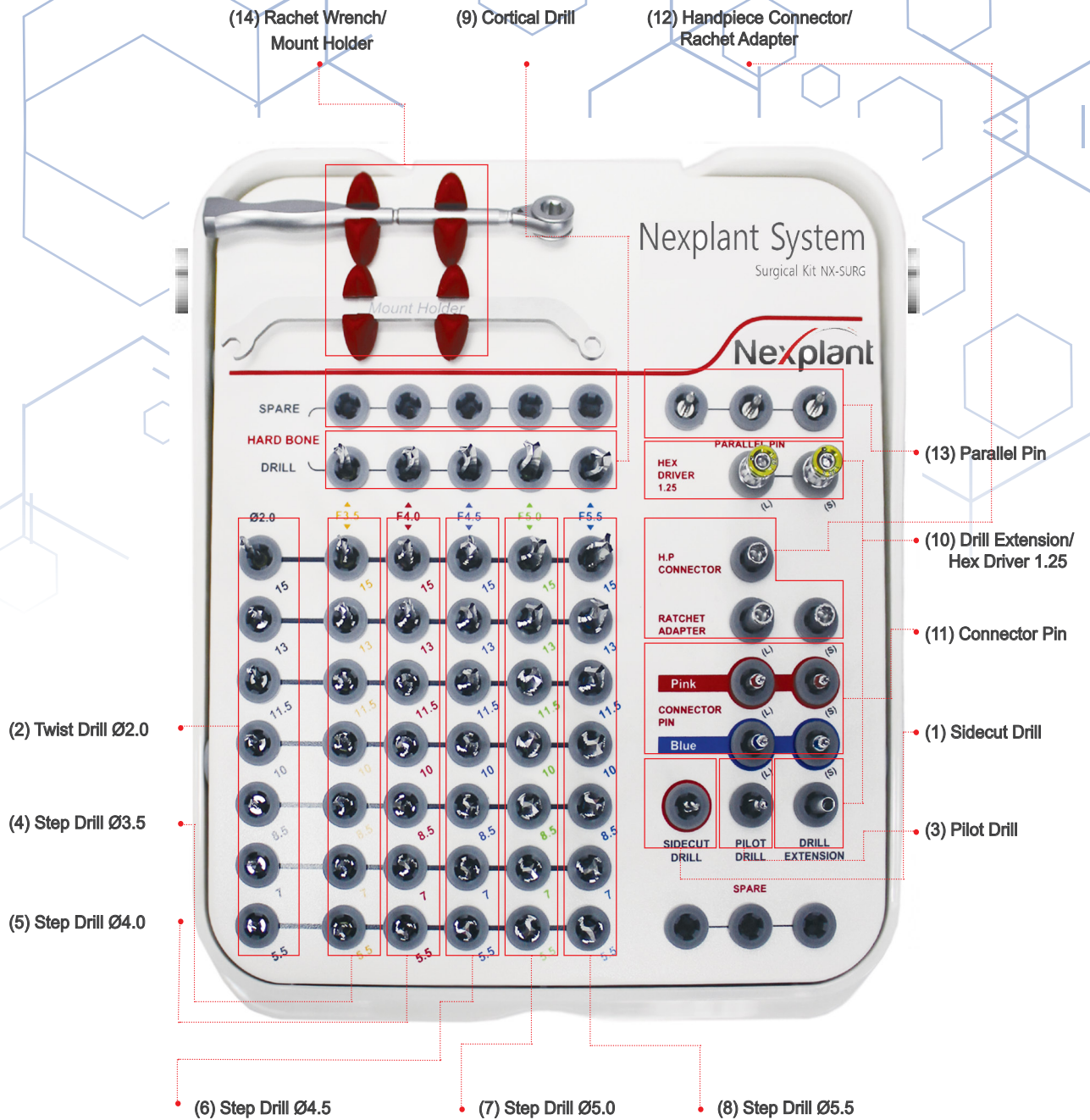

# Nexplant Drilling Sequence & Mini Surgical Kit

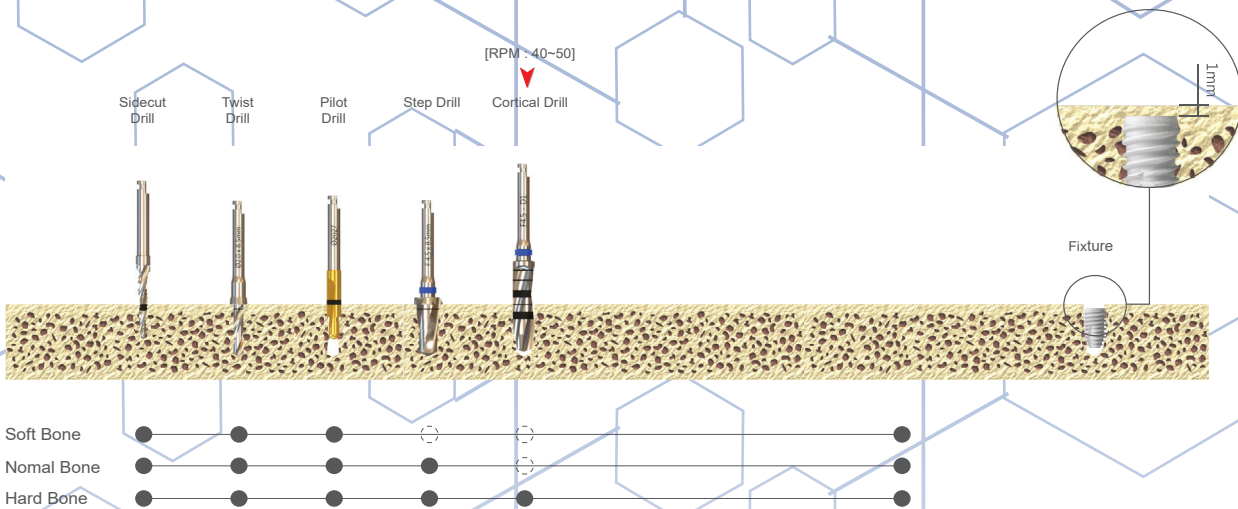

(9) Ratchet Wrench

## NK-MSURG

